







## FICHA TÉCNICA

Solape De 35Mm Para Marco 45Mm. Espesor 1.4 Mm. Largo 5.85 Mts.  
Acabado Anodizado Silver 15 Micron.

**CÓDIGO:**  
**U030 - SILVER**

Solape de 35 para marco de 45 mm			
<b>Código: U030</b>		Peso (kg/m): 0.329	
Perimetro Total (mm): 194		Espesor general = 1.4	
Perimetro Ext. (mm): 194		Aleación-Temple = 6063 T5	
a	---	b	---
c	---	d	---

Acabados disponibles:

					
Anodizado natural	Lacado Blanco	Anodizado Negro	Anodizado Bronce	Lacado texturizado Gris oscuro	Lacado de madera

**LONGITUD 5.85 MTS** \*Consultar disponibilidad de diferentes acabados.

**Código:** U030 - SILVER

**Código de producto:** U030 - SILVER

**Peso (Kg):** 1.9 Kg

**Tipo:** Serie Perimetral Abatible de 45 mm

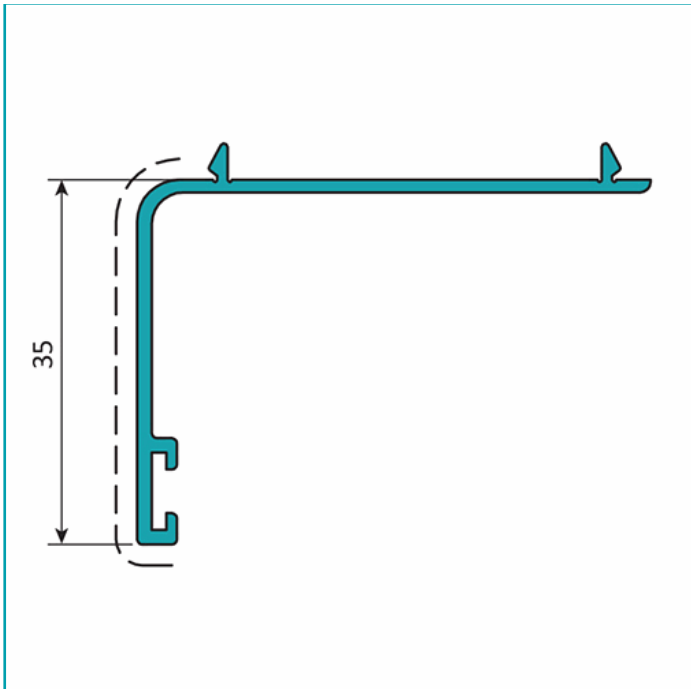

Solape de 35 para marco de 45 mm			
<b>Código: U030</b>		Peso (kg/m): 0.329	
Perimetro Total (mm): 194		Espesor general = 1.4	
Perimetro Ext. (mm): 194		Aleación-Temple = 6063 T5	
a	---	b	---
c	---	d	---

Acabados disponibles:



Anodizado natural



Lacado Blanco



Anodizado Negro



Anodizado Bronce



Lacado texturizado Gris oscuro



Lacado de madera

LONGITUD 5.85 MTS

\*Consultar disponibilidad de diferentes acabados.