

FICHA TÉCNICA

Esquinero Marco 45 Mm. Espesor 1.4 Mm. Largo 5.85 Mts. Acabado Anodizado Silver 15 Micron.

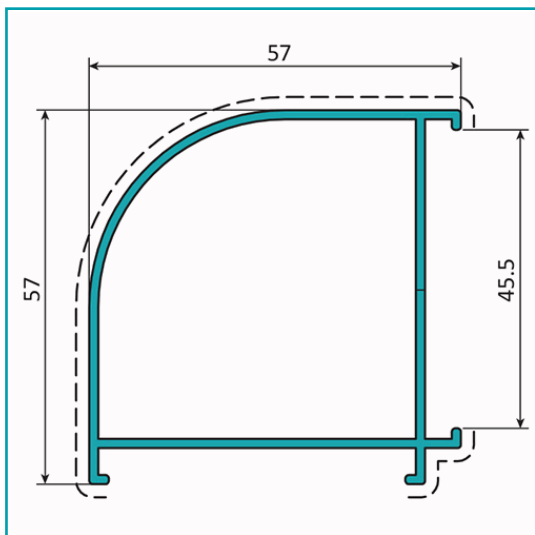







CÓDIGO:

U026 - SILVER

Esquinero 90° para marco de 45 mm			
Código: U026		Peso (kg/m): 0.815	
Perímetro Total (mm): 430		Espesor general = 1.4	
Perímetro Ext. (mm): 247		Aleación-Temple = 6063 T5	
a	---	b	---
c	---	d	---

Acabados disponibles:

 Anodizado natural	 Lacado Blanco	 Anodizado Negro	 Anodizado Bronce	 Lacado texturizado Gris oscuro	 Lacado de madera
---	---	---	--	--	---

LONGITUD 5.85 MTS *Consultar disponibilidad de diferentes acabados.

Código de producto: U026 - SILVER

Marca: CARBONE

Peso (Kg): 5 Kg

Tipo: Serie Perimetral Abatible de 45 mm





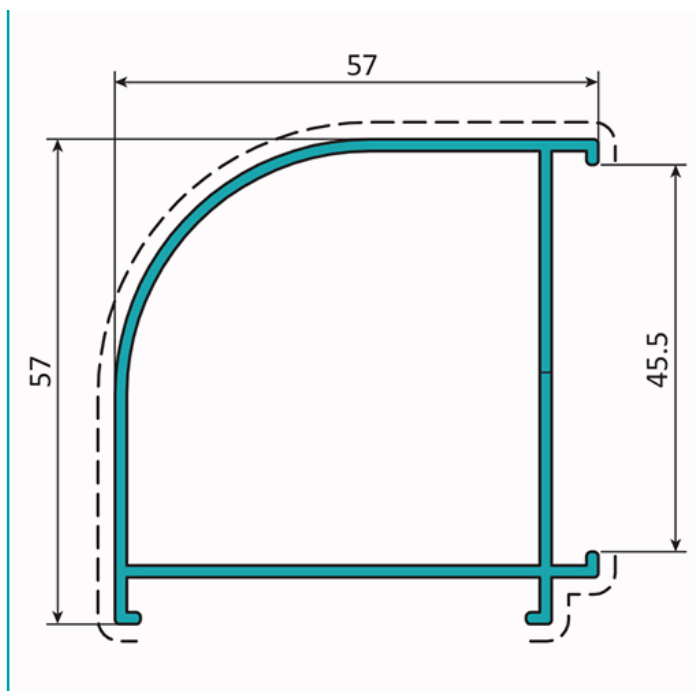

INFORMACIÓN ADICIONAL

Esquinero Marco 45 Mm. Espesor 1.4 Mm. Largo 5.85 Mts. Acabado Anodizado Silver 15 Micron.



Esquinero 90° para marco de 45 mm			
Código: U026		Peso (kg/m): 0.815	
Perímetro Total (mm): 430		Espesor general = 1.4	
Perímetro Ext. (mm): 247		Aleación-Temple = 6063 T5	
a	---	b	---
c	---	d	---

Acabados disponibles:

 Anodizado natural	 Lacado Blanco	 Anodizado Negro	 Anodizado Bronce	 Lacado texturizado Gris oscuro	 Lacado de madera
---	---	--	--	--	--

LONGITUD 5.85 MTS *Consultar disponibilidad de diferentes acabados.